

Colour the object that has **more** volume.

Takes up **more** space.

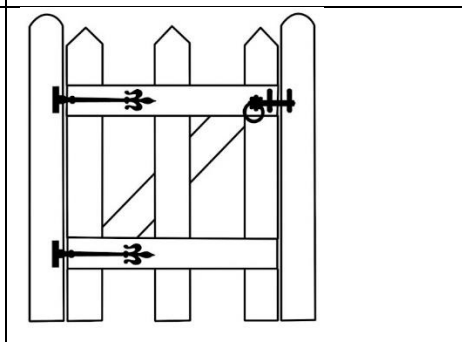
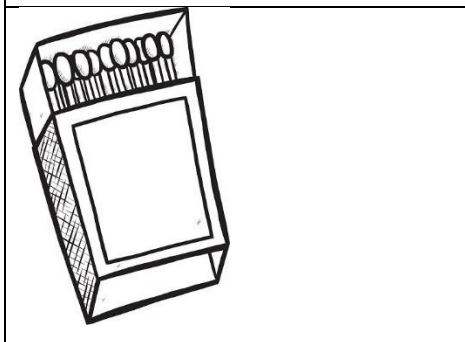
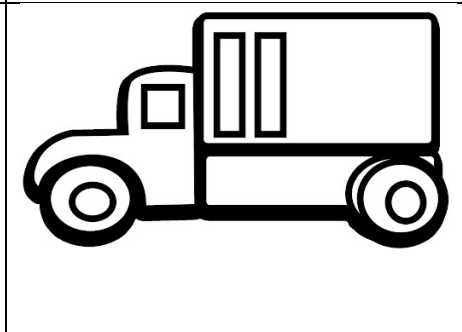
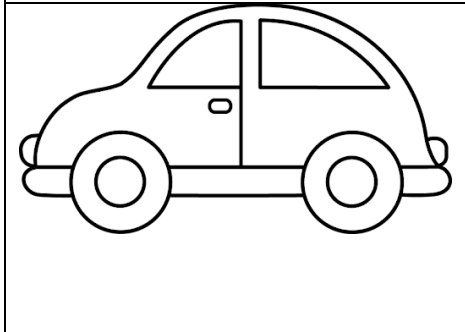
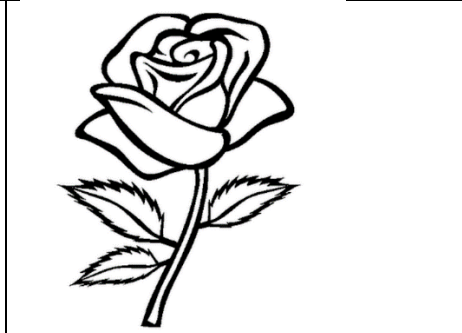

Colour the object that has **less** volume.

Takes up **less** space.

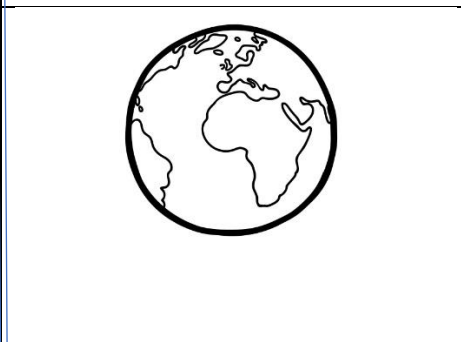
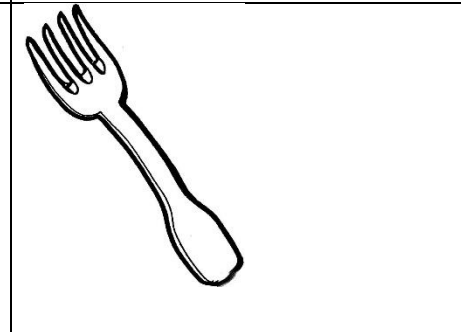
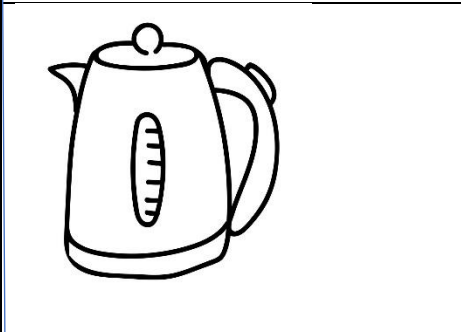
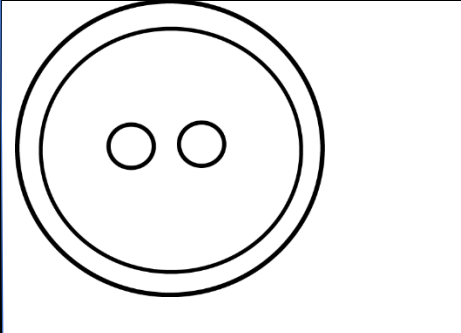

Volume

Recreate each volume. Label which volume has more and which has less when compared to the other. Example:



more

less

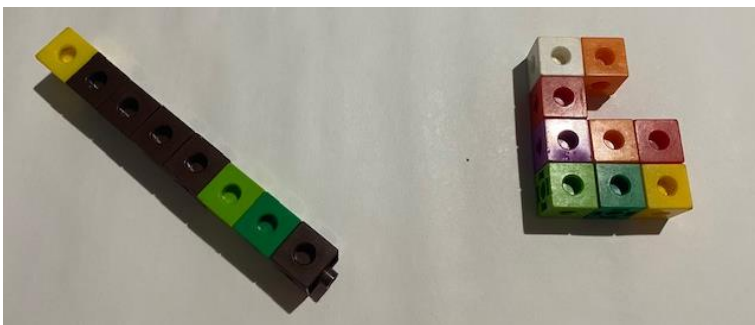
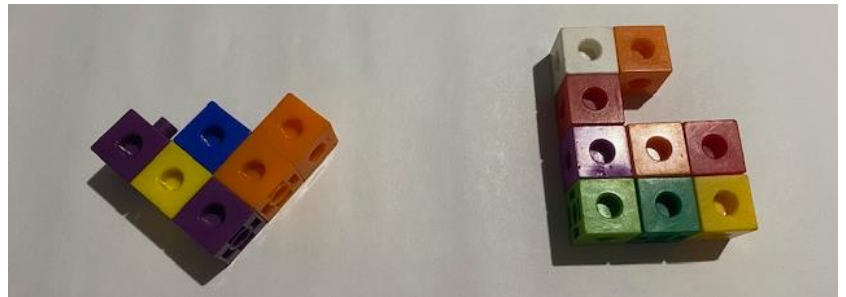
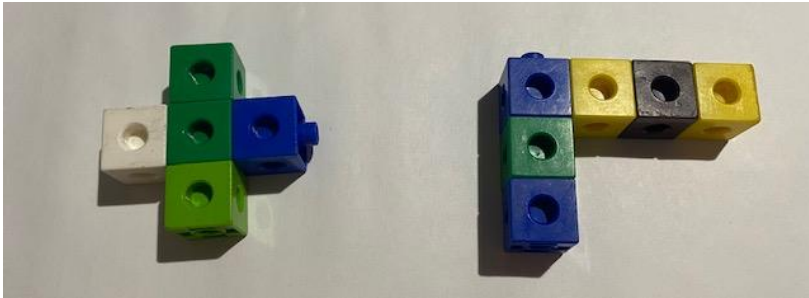

Name _____

Compare Capacity

Compare the two containers. Circle the container that would hold more. Draw an X on the container that would hold less. Circle both of the containers if they would hold the same amount.

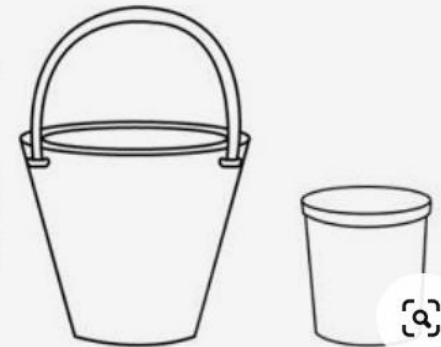
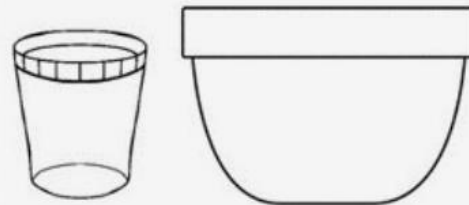
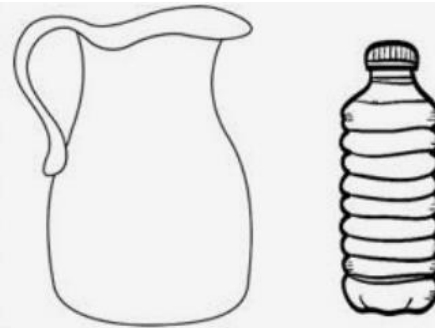
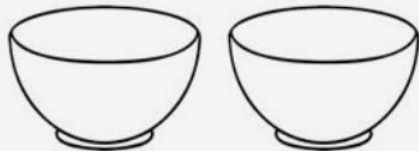
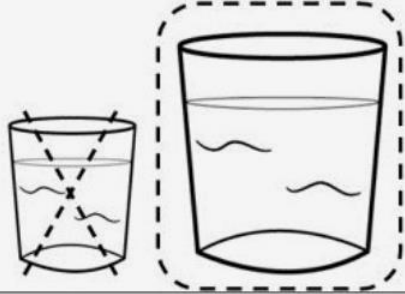

Net of a cube for Maths Warm Up Activities.

Draw the numbers 1–6 in each square, carefully cut out the net, fold the lines and tape the edges together.

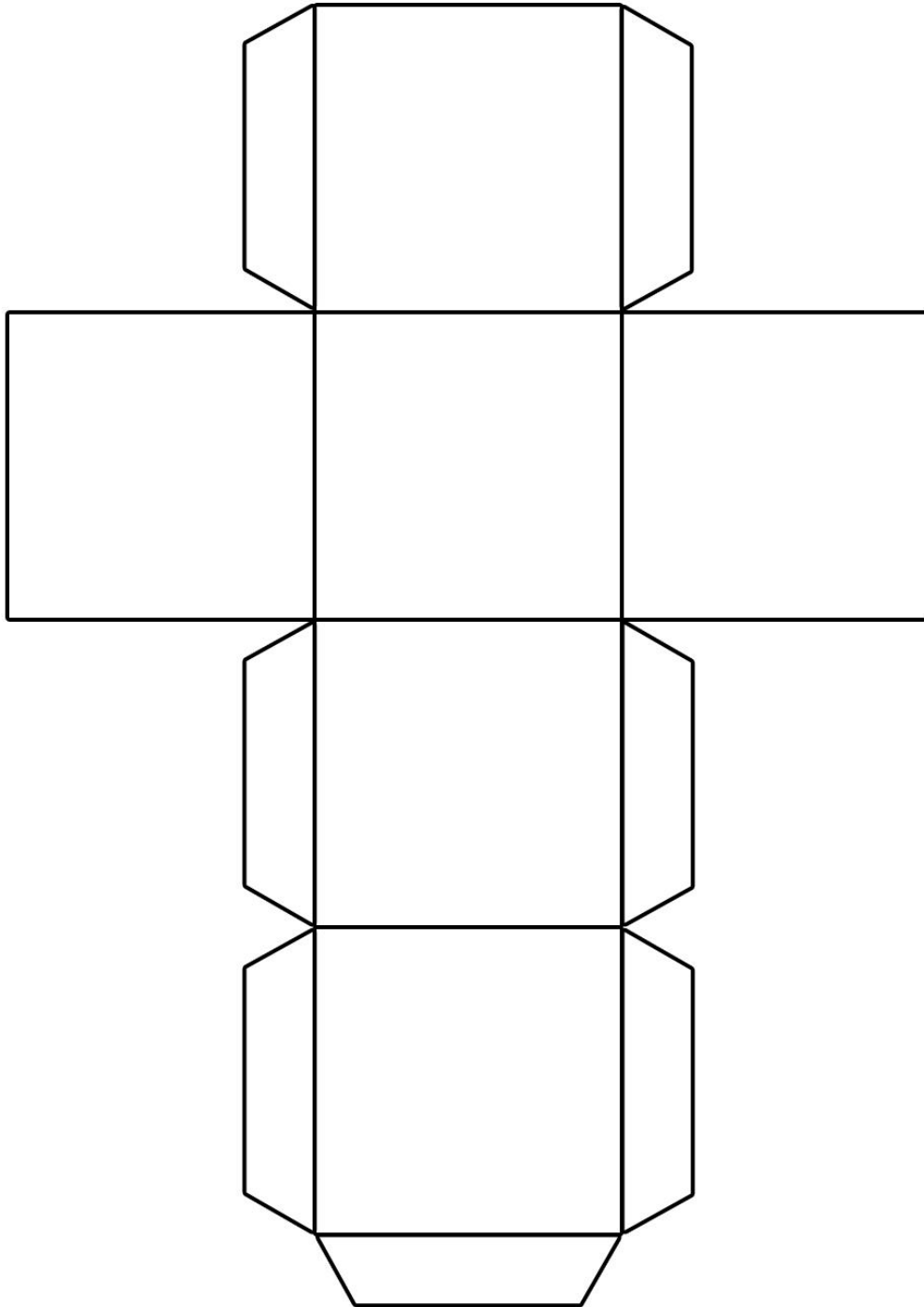

Cut out Teddy Cards for Maths Warm Up Activities

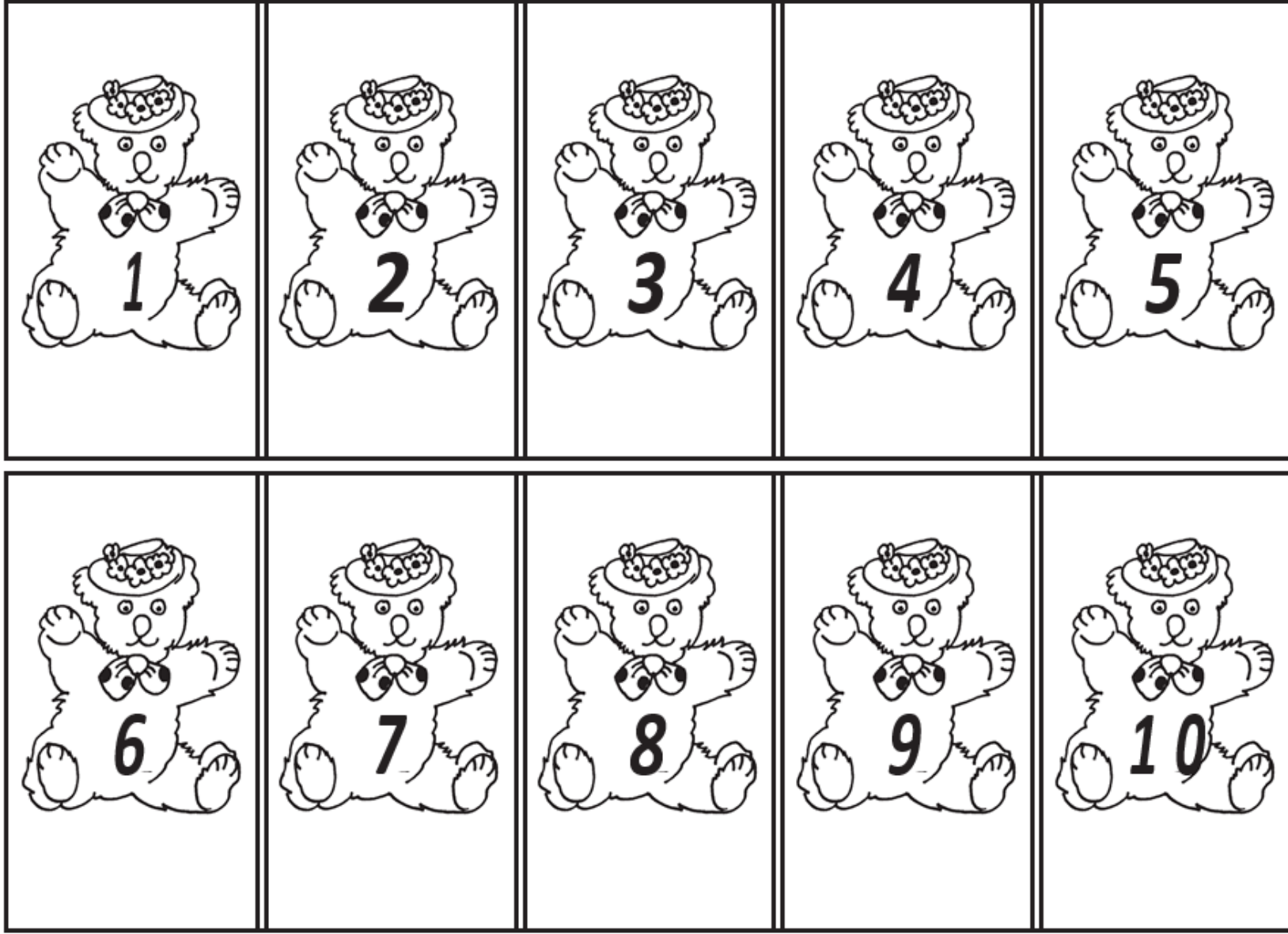

Cut out Teddy Cards for Maths Warm Up Activities

